

# **Bray** CONTROLS

A Division of BRAY INTERNATIONAL, Inc.



**BRAY / McCANNALOK**

Wafer, Lug and Double Flange High Performance Valves

# BRAY / McCANNALOK

## HIGH PERFORMANCE, HIGH PRESSURE, HIGH TEMPERATURE, ZERO LEAKAGE BUTTERFLY VALVES

- Wafer, Lug and Double Flanged
- ASME:
  - Class 150 2 1/2 - 60" (65-1500 mm)
  - Class 300 2 1/2 - 54" (65-1370 mm)
  - Class 600 3 - 30" (80-750 mm)
- -20°F to 500°F (-29°C to 260°C)
- Zero-Leakage, Bi-directional Shut-off to Full Rated Pressure  
Bray standard shut-off testing surpasses API 598 requirements.



Bray Controls is proud to offer the Bray/McCannalok line of high performance butterfly valves. This product line is recognized as a proven leader with over 30 years of successful service in process industries worldwide.

The Bray/McCannalok's unique, patented design received Chemical Processing's Vaaler Award for Best Product shortly after it was introduced. The simple, innovative design offers rugged reliability and extremely easy maintenance in the field. Independent and internal tests have proven Bray/McCannalok's superior service life capability, with zero-leakage shut-off through over 100,000 cycles. The Bray/McCannalok valves can be automated inexpensively with Bray's pneumatic and electric actuators. The Bray/McCannalok High Performance Valve delivers the highest quality and highest value available for your requirements.

*For over 30 years the reliability of the Bray/McCannalok has been conclusively proven, both in lab tests and thousands of field applications.*

After a test of over 100,000 cycles at 720 psi, the seat remained in excellent condition, continuing to provide a bi-directional zero-leakage seal. Even after more than 878,000 cycles at 2 psi, the Bray/McCannalok High Performance Valve still sealed zero-leakage in both directions.

### SEAT DESIGN: THE HEART OF THE BRAY/McCANNALOK VALVE

The unique, two-part seat assembly consists of a resilient energizer which is totally encapsulated by the seat. The assembly is locked in the body recess by a full-faced seat retainer. This simple, reliable and proven combination results in many exclusive advantages including:

- The energizer is completely isolated from all contact with the line media by the seat.
- Serrations in the seat retainer and body recess secure the seat assembly in place regardless of disc position.
- The full-faced retainer is bolted to the body, locking the seat in the correct position. The seat is secured even without the mating flange.
- The closely confined and well supported seat is energized by the disc and line pressure. The higher the pressure, the tighter the seal. In low pressure and vacuum applications, the energized seat offers superior sealing and longer service life than many other designs.
- Line media is sealed to zero-leakage in both directions.
- The seat is self-adjusting for wear and temperature changes.
- Seat replacement is extremely easy. Just remove the seat retainer, rotate the disc into the closed position and place a new seat assembly in the machined recess of the body. This simple procedure will not disturb the disc or stem.

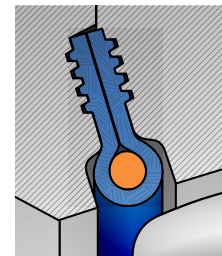

Seat non-compressed as disc approaches.

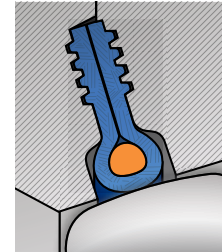

Disc in closed position; with no line pressure.

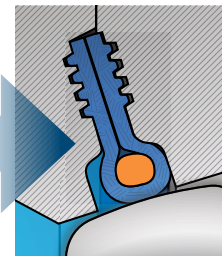

Disc in closed position; line pressure applied from the left.

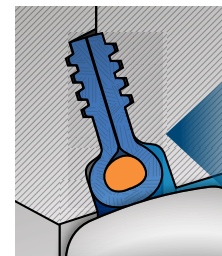

Disc in closed position; line pressure applied from the right.

### DOUBLE OFFSET STEM AND DISC DESIGN

The double offset design of the Bray/McCannalok assures reduced seat wear and bidirectional, zero leakage shut off throughout the full pressure range.

At the initial point of disc opening, the offset disc produces a cam-like action, pulling the disc from the seat. This cam-like action reduces seat wear and eliminates seat deformation when the disc is in the open position. When open, the disc does not contact the seat, therefore seat service life is extended and operating torques are reduced. As the valve closes, the cam-like action converts the rotary motion of the disc to a linear type motion to effectively push the disc onto the seat. The wiping action of the disc against the seat prevents undesirable material build-up from slurries or suspended solids.

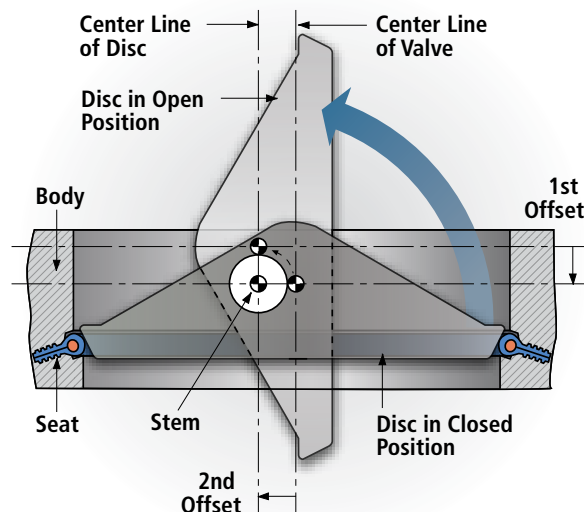



**DEAD-END SERVICE:** Bray/McCannalok lug and double flange bodies are full rated for bi-directional dead-end service.

**STEM:** The high-strength, one piece stem is 17-4 PH Stainless Steel. The valve stem is standardized for interchangeability of Bray actuators.

**BLOW-OUT PROOF STEM:** A retaining ring is installed between the machined stem groove and gland retainer step.

**ADJUSTABLE STEM PACKING:** The stem packing system features easy access to adjusting hex head nuts without requiring removal of the actuator. The system consists of a gland ring, a gland retainer, studs, hex head nuts and lock washers. A 1/4 turn of the hex head nuts is usually all that is required should field adjustment ever be needed. Both hex head nuts must be evenly adjusted and not overtightened.

**STEM SEAL:** The stem seal system provides constant compression for a positive seal around the stem. PTFE packing seals the stem and a carbon fiber anti-extrusion ring contains the packing. Flexible graphite rings are available for high temperature applications and are standard on fire safe valves.

**STEM BEARINGS:** Top and bottom bearings, consisting of a 316 Stainless Steel shell with a TFE/glass fabric liner bearing surface securely support the stem. The stem bearings provide excellent resistance to corrosion and distortion from high temperatures and mechanical loading forces.

**TAPER PINS:** Taper pins are precision fit into reamed holes.

**DISC:** The disc has been engineered to maximize flow and minimize resistance providing a high  $C_v$ . Stainless Steel is standard.

**INTERNAL OVER-TRAVEL STOP:** Designed to prevent over travel of the disc and minimizing possible seat damage, therefore extending the service life of the seat.

**RESILIENT SEAT:** Energizer encapsulated in RTFE

**FULL-FACED SEAT RETAINER:** Retainer is firmly attached by bolts located outside of sealing area, protecting the bolts from corrosion.

**BODY:** All body styles offer bi-directional sealing as standard to full ASME Class 150, 300 or 600 ratings. Extended neck allows for 2" of pipeline insulation and easy access to stem packing adjustments and actuator mounting.



**Bray / McCannalok valves can be optionally supplied in a number of different seat and body materials including:**

- PTFE and UHMWPE seats with resilient energizer.
- Fluorosilicone inner O-rings for methylene chloride service.
- Fire Safe graphite/carbon fiber or similar packing for fire safe or high temperature service
- Hastelloy C bodies for hydrogencyanide service.
- Nickel Aluminum Bronze bodies for marine environments.
- Longer stem lengths to accommodate differing control devices.
- Alloy 20 trim for sulfuric acid service.
- Monel discs for Chlorine service.
- Duplex, Super Duplex and Super Austenitic Stainless trims for salt water services.

**Many other materials are also available. Please consult your Bray representative.**

# APPLICATIONS

Bray/McCannalok valves handle a wide range of conditions and media such as corrosive chemicals, water, gases, acids, alkalis, hydrocarbons plus many other fluids. Bray's standard valve line has been specifically designed to meet most applications. When applications demand special requirements, Bray offers valves and materials that meet these needs.

## Fire-test standards API 607 5th Edition Certified.

*The Bray/McCannalok FIRE SAFE has been thoroughly tested and meets or exceeds the latest international fire test standards.*

*Since its introduction the FIRE SAFE design has passed field applications and lab tests with flying colors, delivering superior performance under the most demanding conditions*



## FIRE SAFE

Bray/McCannalok High Performance Valves are available with proven bidirectional fire safe seats on:

**Wafer, Lug and Double Flange bodies:**

ASME Class 150 2 1/2 - 40" (65-1000 mm)

ASME Class 300 2 1/2 - 24" (65-600 mm)

ASME Class 600 3 - 14" (80-350 mm)

For reliable control of flammable and hazardous fluids in petroleum, petrochemical, chemical and other high-risk applications, the fire safe DESIGN combines superior performance, extended service life and compliance with the most demanding worldwide fire-test standards – before, during and after a fire!

In normal service, the Fire Safe combination resilient/metal seat seals zero-leakage in both directions of line media flow through the full rated pressure and temperature ranges. When closed, the disc remains compressed against the resilient mechanically loaded seat, which is securely locked in place by a full-faced retainer. Line media pressure strengthens the seal.

In the event of a fire, if excessive heat destroys the resilient seat materials, either partially or completely, the seat provides a constant metal-to-metal backup seal.

In real actual fire conditions, line pressure is immediately reduced and the entire area is hosed down. The resulting pressure drop and rapid cool down causes many valves to fail. The Fire Safe design does not rely on line media pressure to seal, therefore the valve offers superior low pressure performance to competitive designs. The Inconel® metal seat functions as a spring mechanism, which allows for expansion and contraction without breaking contact with the disc. Additionally, the Inconel seat offers better corrosion and heat resistance and greater strength than the stainless steel seats commonly used.

The Bray/McCannalok delivers proven fire safe protection not only in the lab, but also where it counts the most – in the field.

## FIRE SAFE SEAT OPERATION

The seat assembly in normal service contacts the disc with both the resilient seat and metal seat. During and after a fire, when the resilient has been partially or completely destroyed, the metal seat provides a positive seal by remaining in constant contact with the disc in either direction of media flow.

*\*Inconel® is a registered trademark of Inco Alloys International, Inc.*

### THE FIRE SAFE SEAT in normal service

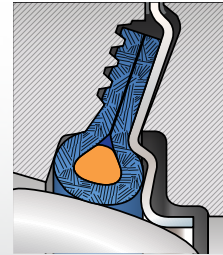

Bi-directional Resilient Seat with O-ring Energizer / Inconel® Seat

### SEAT DURING & AFTER FIRE with disc sealing load and line media pressure acting on the seat



Seat retainer downstream

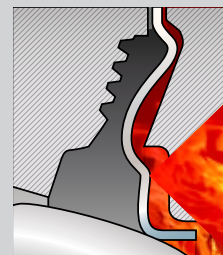

Seat retainer upstream



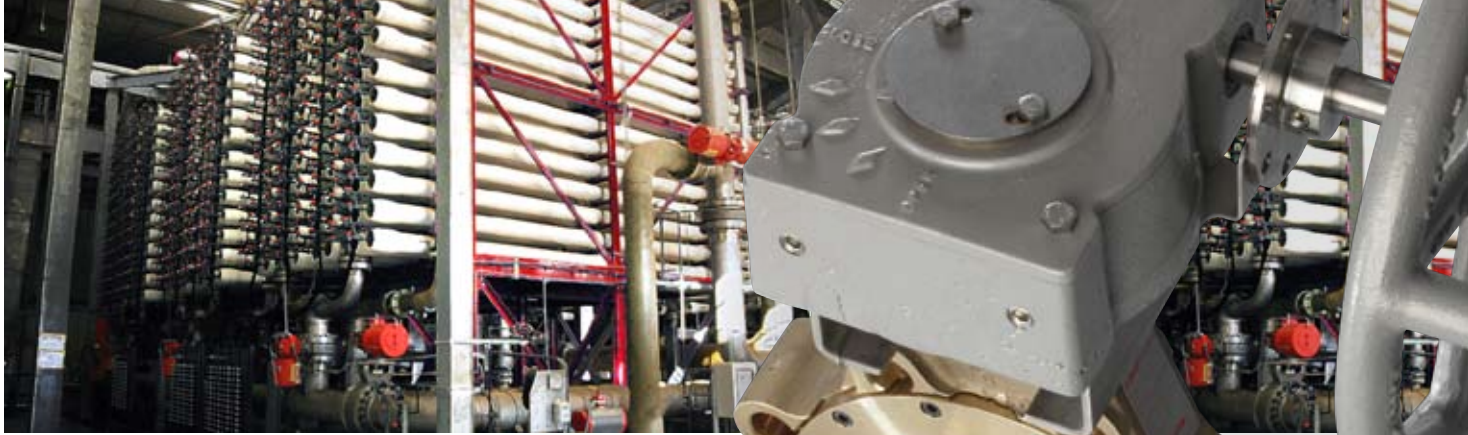

**SEA WATER:** Bray/McCannalok valves have been successfully installed in power plants, desalination plants and offshore drilling projects. Duplex, super duplex and super austenitic stainless trims can be provided for sea water service. Higher alloy materials are available.

**HEATING, VENTILATION AND AIR CONDITIONING (HVAC):** Bray/McCannalok valves can be used for damping or balancing water flow, main stop valves, block valves, throttling valves and control of pump suction or discharge.

**OXYGEN:** Bray/McCannalok valves for critical gaseous oxygen service are specially prepared, cleaned, inspected, assembled and tested to ensure removal of all burrs, sharp edges, dirt, hydrocarbon oil or grease and other contaminants. Each valve is individually wrapped and sealed in polyethylene before shipment.

**VACUUM:** Standard Bray/McCannalok valves with RTFE seats are recommended for vacuum service down to .02 mm Hg absolute pressure, or 20 microns. For vacuum service down to  $1 \times 10^{-3}$  mm Hg absolute pressure, or 1 micron, specially prepared valves are recommended. Under certain conditions, these valves serve well in the high vacuum range down to  $1 \times 10^{-6}$  mm Hg absolute pressure.

**STEAM:** Bray/McCannalok valves are specifically designed for a wide range of high temperature and high pressure applications including on-off and modulating control of hot water, condensed water or chilled water. The Bray/McCannalok valve is rated 150 psi (10.3 bar) saturated steam at 366°F (185°C) for on-off applications. For modulating service, the Series 40 is rated 50 psi (3.4 bar) at 300°F (149°C). Use of the standard RTFE seat is recommended for this service.

**CAUSTIC:** Valve materials must be selected for sufficient corrosion requirements. Stainless Steel is recommended for sodium and potassium hydroxide applications.

**DRY CHLORINE (GAS OR LIQUID):** Special materials as well as assembly and testing procedures are applied to assure zero-leakage closure in these critical services.

**SOUR GAS:** Selected materials of construction meeting NACE standards permit ready application and maximum serviceability in these difficult services.

*Please consult you Bray representative for specific recommendations regarding your requirements.*

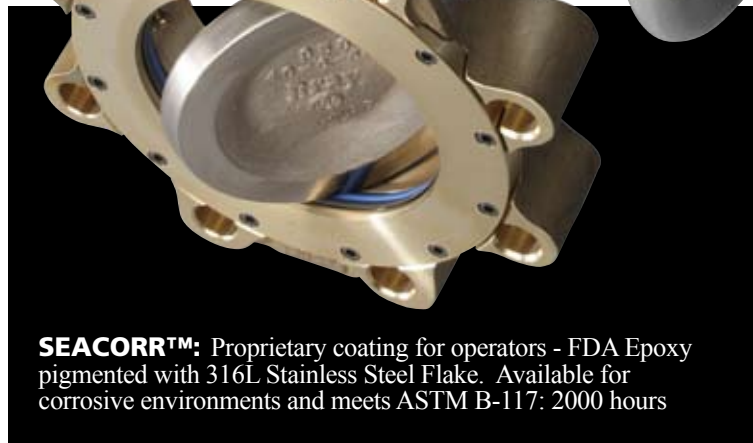
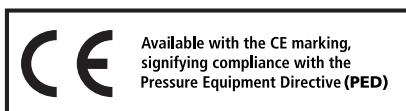

*There are more  
McCannalok  
valves in "N-Stamp"  
installations than  
any other high  
performance butterfly  
valve in the world.*



# BRAY / McCANNALOK

## High Performance Valves

### Offering superior advantages over other valves.

The cost savings of installation and maintenance are substantial. Economy, efficiency and proven superior performance establish the Bray/McCannalok as the premier solution for demanding high pressure applications.

- Torque requirements of the High Performance Bray/McCannalok Butterfly Valves are significantly lower.
- Bray/McCannalok valves require a much smaller actuator than other valves.

When matched against comparably rated plug, globe, gate, ball and diaphragm valves, the reduced weight and space requirements of the Bray/McCannalok is apparent.

The Bray/McCannalok valves can be automated inexpensively with Bray's pneumatic and electric actuators. These actuators directly mount without the need for large brackets or adapters. Bray has designed the most advanced, highest quality line of actuators and accessories available today.

*Bray compact, high torque pneumatic and electric actuators provide low cost automation for on-off and control services.*



### 8 Inch Class 150

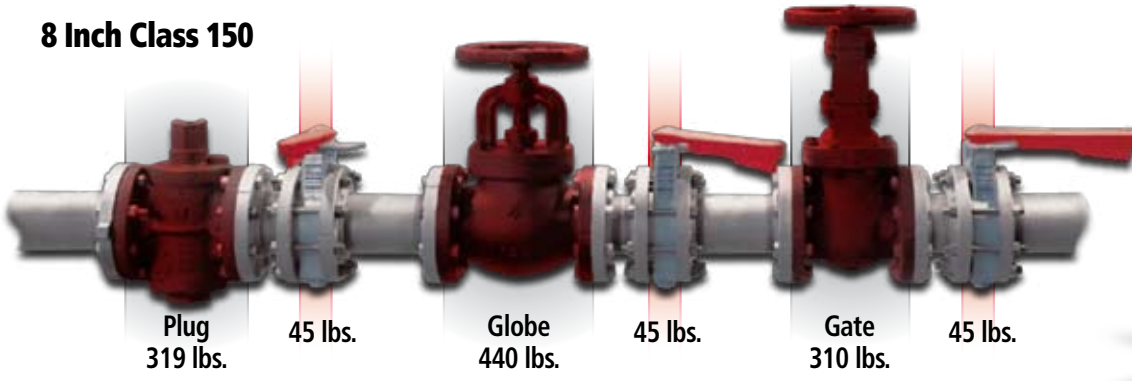

### PRESSURE / TEMPERATURE

Refer to Bray Technical Manual TM-1023 for additional information on Pressure/Temperature Curves for other materials.

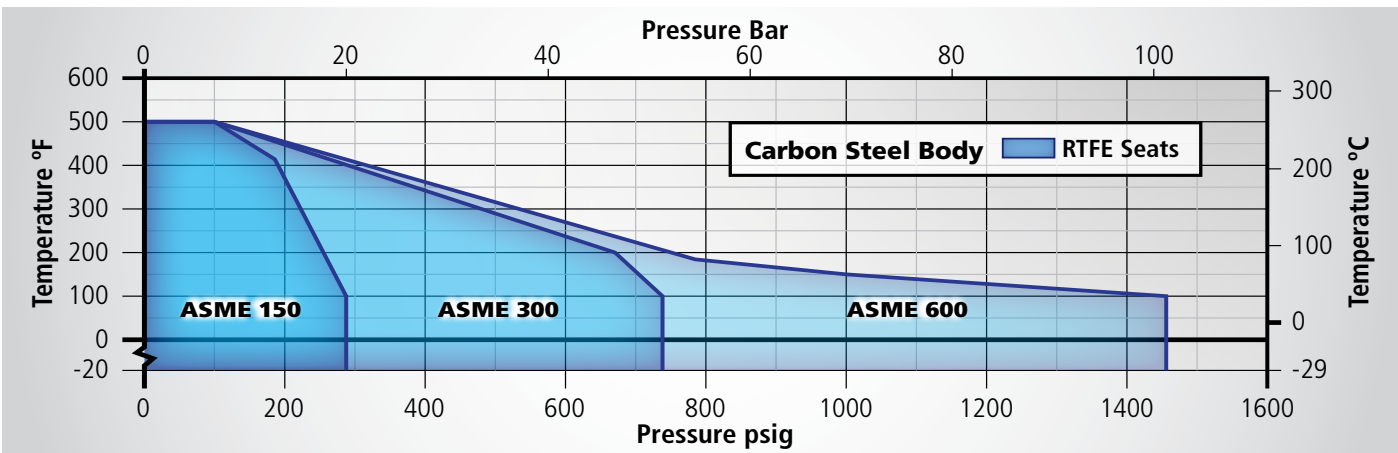
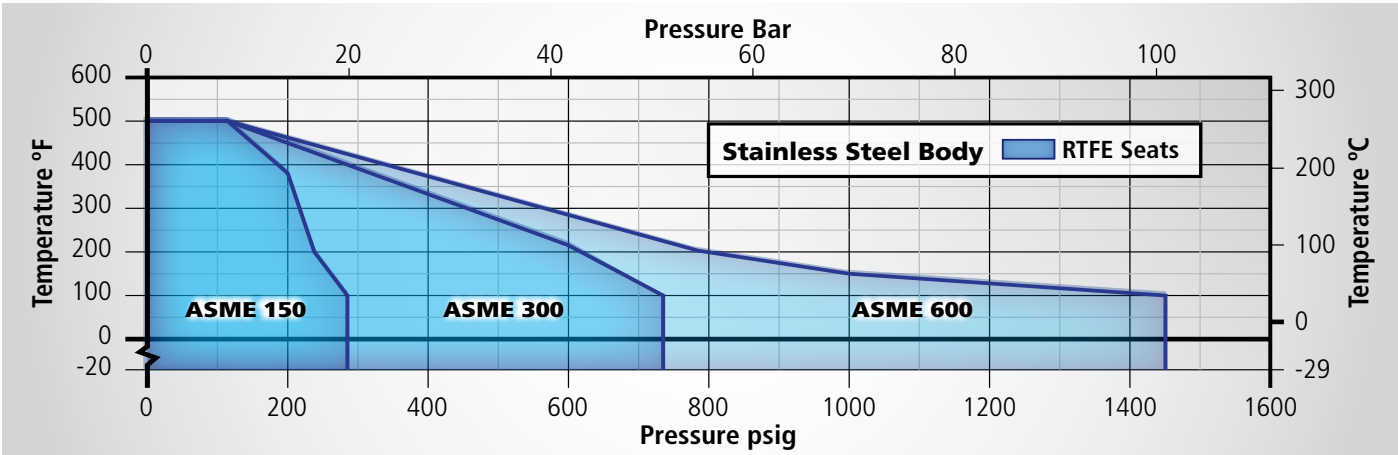





## Materials of Construction

ITEM	NAME	MATERIAL
1	Body	Stainless Steel, ASTM A351 GR CF8M Carbon Steel, ASTM A216 GR WCB /A516 GR 70 Nickel Aluminum Bronze, ASTM B-148 C95800
2	Disc	Stainless Steel, ASTM A351 GR CF8M – Standard with Electroless Nickel Plating on disc edge – Fire Safe Nickel Aluminum Bronze, ASTM B-148 C95800
3	Stem	17-4 PH SS, ASTM A564-Type 630 Monel K500 316 Stainless Steel, ASTM 276 Type 316/A240-316**
4	Taper Pins	17-4 PH SS, ASTM A564-Type 630 Monel K500 Monel K500
5	Disc Spacers	316 Stainless Steel, ASTM 276 Type 316
6	Bearing Assembly	316 Stainless Steel with TFE & Glass Fabric Liner
7	Gland Ring	316 Stainless Steel, ASTM 276 Type 316
8	Stem Seal	PTFE rings plus 1 Carbon Fiber ring – Standard Valve Flexible Graphite rings – Fire Safe Valve
9	Thrust Washer	316 Stainless Steel, ASTM 276 Type 316
10	Retaining Ring	18-8 Stainless Steel
11	Gland Retainer	316 Stainless Steel, ASTM A351 CF8M Carbon Steel, ASTM A216 GR WCB /A516 GR 70
12	Stud	316 Stainless Steel, ASTM A193-B8M
13	Lock Washers	18-8 Stainless Steel
14	Hex Nut	18-8 Stainless Steel
15	Seat Assembly	RTFE♦ with Silicone Rubber Energizer PTFE with Silicone Rubber Energizer
16	Seat Retainer Plate	Stainless Steel, ASTM A351 CF8M /A240-316 Carbon Steel, ASTM A216 GR WCB /A516 GR 70
17	Cap Screws	18-8 Stainless Steel Alloy Steel
18	Gasket	PTFE – Standard Valve Flexible Graphite – Fire Safe Valve
19	Locating Plug	316 Stainless Steel, ASTM 276 Type 316/A240-316 Carbon Steel, Phosphate Coated
20	Mounting Plate	18-8 Stainless Steel Carbon Steel, Phosphate Coated
21	Cap Screws	18-8 Stainless Steel Alloy Steel
22	Lock Washers	18-8 Stainless Steel Alloy Steel
23	Metal Seat*	Inconel® 718, ASTM B670 – Fire Safe Valve
24	Gasket*	Flexible Graphite

Not Shown: Bellville Washer and Grounding Washer: 18-8 Stainless Steel, for 14" – 54" Class 150, 14" – 48" Class 300 and 10" – 30" Class 600 valves

♦ RTFE is supplied by Bray as RPTFE (reinforced polytetrafluoroethylene).

\* Fire Safe Valve only.

\*\* May require pressure rating to be reduced.

### BLOW-OUT PROOF STEM

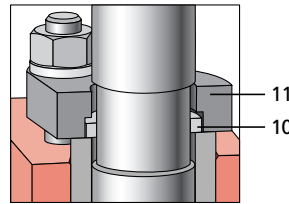

### FIRE SAFE Valve

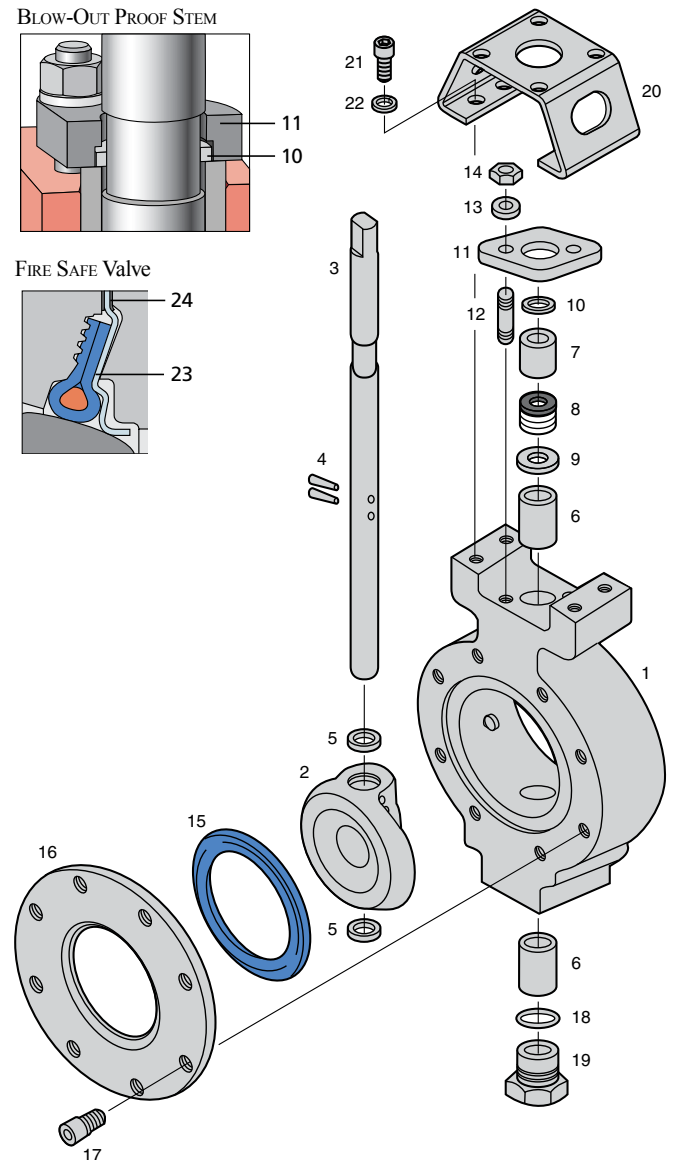
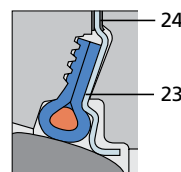

**Other materials are available.  
Please consult Bray representative for your specific application.**

**BRAY CONTROLS - USA**  
Houston, TX. (281) 894-5454

**BRAY CONTROLS - CHINA**  
Hangzhou, Zhejiang +86-571-82852200

**BRAY CONTROLS - CANADA,**  
Quebec (514) 344-2729

**BRAY CONTROLS - UNITED KINGDOM**  
Inchinnan +44-141-812-5199

**BRAY CONTROLS - MEXICO**  
Zapopan, Jalisco, C.P. +52-33-3836-4460

**BRAY CONTROLS - BRAZIL**  
Bairro Cascata Paulinia SP-Brazil +55-19-3844-6161

**BRAY CONTROLS - BENELUX**  
Netherlands +31-(0)72-572-14-10

**BRAY PACIFIC - AUSTRALIA**  
Braeside, Vic +61-39580-9755

**BRAY CONTROLS - CHILE**  
Centro de Empresas +56-2-949-1875

**BRAY CONTROLS - GERMANY**  
Krefeld +49-2151- 5336-217

**BRAY CONTROLS - POLAND**  
Oswiecim +48-33-842-19 68

**BRAY CONTROLS - INDIA**  
Gujarat, +91-265-2633868

**FLOW-TEK - USA**  
Houston, TX. (832) 912-2300

**FLOW-TEK - CHINA**  
Hangzhou, Zhejiang

**RITEPRO - CANADA**  
Quebec (514) 324-8900



**BRAY CONTROLS - USA. - Office & Manufacturing**



***Global Manufacturing,  
Service Around the Corner***

**To serve you locally, each region maintains a Factory  
Certified sales, assembly, testing and service network  
for all Bray International products.**



**BRAY CONTROLS - CHINA Office & Manufacturing**

 **Bray** **CONTROLS**

A Division of BRAY INTERNATIONAL, Inc.  
13333 Westland East Blvd. Houston, Texas 77041  
281.894.5454 FAX 281.894.9499 [www.bray.com](http://www.bray.com)

All statements, technical information, and recommendations in this bulletin are for general use only. Consult Bray representatives or factory for the specific requirements and material selection for your intended application. The right to change or modify product design or product without prior notice is reserved. Patents issued and applied for worldwide.

Bray® is a registered trademark of BRAY INTERNATIONAL, Inc.  
© 2009 Bray International. All rights reserved.

B-1023\_EL\_S40\_2009-11